

FUTURE FLEX

ADDRESS

Hårup Skovvej 2
8600 Silkeborg
Danmark

CONTACT

+ 45 86 81 23 75
info@pj-production.dk

WEBSITES

www.pj-production.dk/eng
www.aptocollection.dk/eng



FUTURE FLEX

FOR ONE OR TWO MONITORS

Ergonomics is about adapting the workplace to one's own needs, thus avoiding unsuitable working positions. With Future Flex, you get maximum comfort and accessibility, as the screen(s) have full rotation, optimal tilt options, - both up and down, as well as height adjustment.

CHARACTERISTCA:

- Future Flex embraces the clean desk policy, as the monitor solution has integrated storage, thus reducing visible wires and cables behind the screen.
- Full rotation, optimal tilt options - both up and down, as well as height adjustment. (adjusted with a 4 mm Allen key)
- Max 2 monitors of 27" and 8 kg.

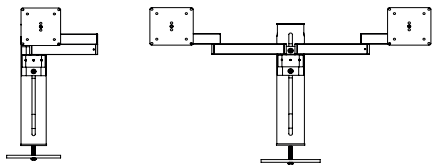

FUTURE FLEX - ONE MONITOR

Furure Flex with desk clamp // 4510-9005-K

Included one vesa mount and one extension arm

Monitor pole: 350 mm. // Extension arm: 1x334 mm.

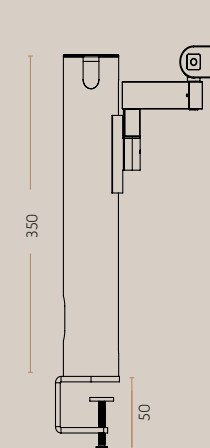
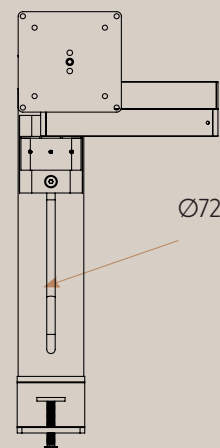
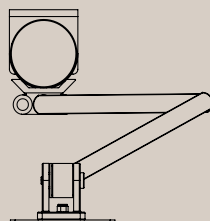

FUTURE FLEX - ONE MONITOR

Furure Flex Through-desk mount // 4510-9005-G

Included one vesa mount and one extension arm

Monitor pole: 350 mm. // Extension arm: 1x334 mm.

Pre-drilling in table: hole size $\text{Ø}64$

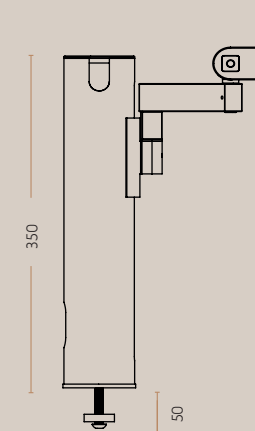
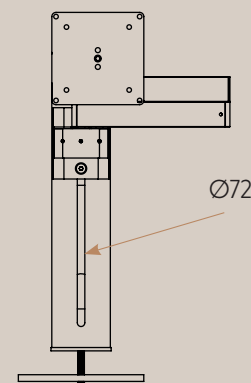
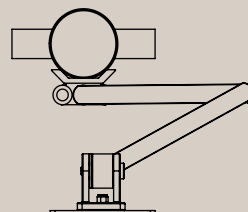

FUTURE FLEX - TWO MONITORS

Furure Flex with desk calmp // 4511-9005-K

Included two vesa mount and two extension arms

Monitor pole: 350 mm. // Extension arm: 2x334 mm.

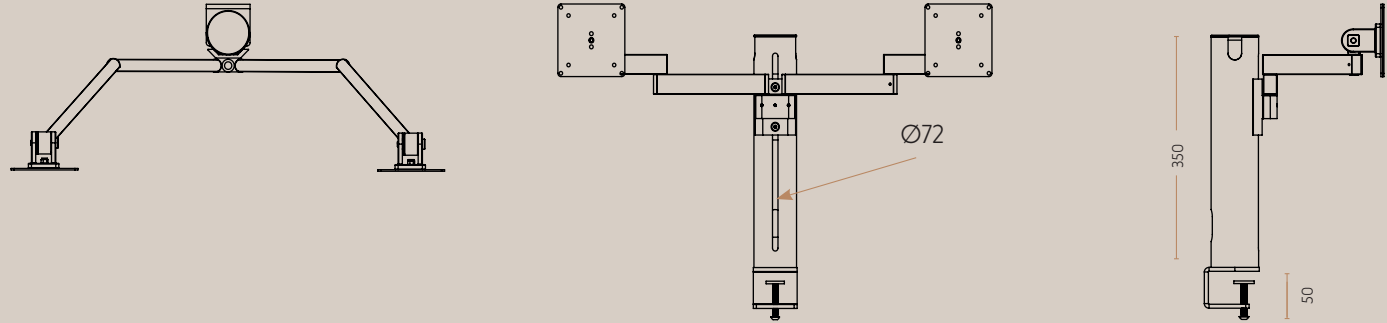

FUTURE FLEX - TO SKÆRME

Furure Flex Through-desk mount // 4511-9005-G

Included two vesa mount and two extension arms

Monitor pole: 350 mm. // Extension arm: 1x334 mm.

Pre-drilling in table: hole size $\text{Ø}64$

